

KINS114

## Grand sac shopping recyclé à soufflet

- Poche intérieure zippée.
- En matières recyclées, 100% écoresponsable.

Coton recyclé / polyester recyclé. 75% coton recyclé / 22% polyester recyclé / 3% autres fibres (Ecume), 67% coton recyclé / 30% polyester recyclé / 3% autres fibres (Black Night). Anses contrastées cousues tout le long du corps du sac. Poche intérieure avec fermeture zippée. Fermeture à bouton magnétique.



Tableau équivalence des tailles par pays en dernière page.

### Certifications

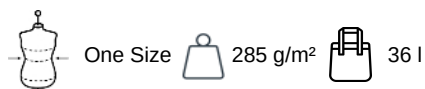

### Informations Complémentaires

#### Logistique



#### Pays d'origine

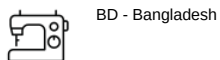

#### Code douanier

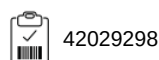

KINS114

## Grand sac shopping recyclé à soufflet

Dimensions (cm)

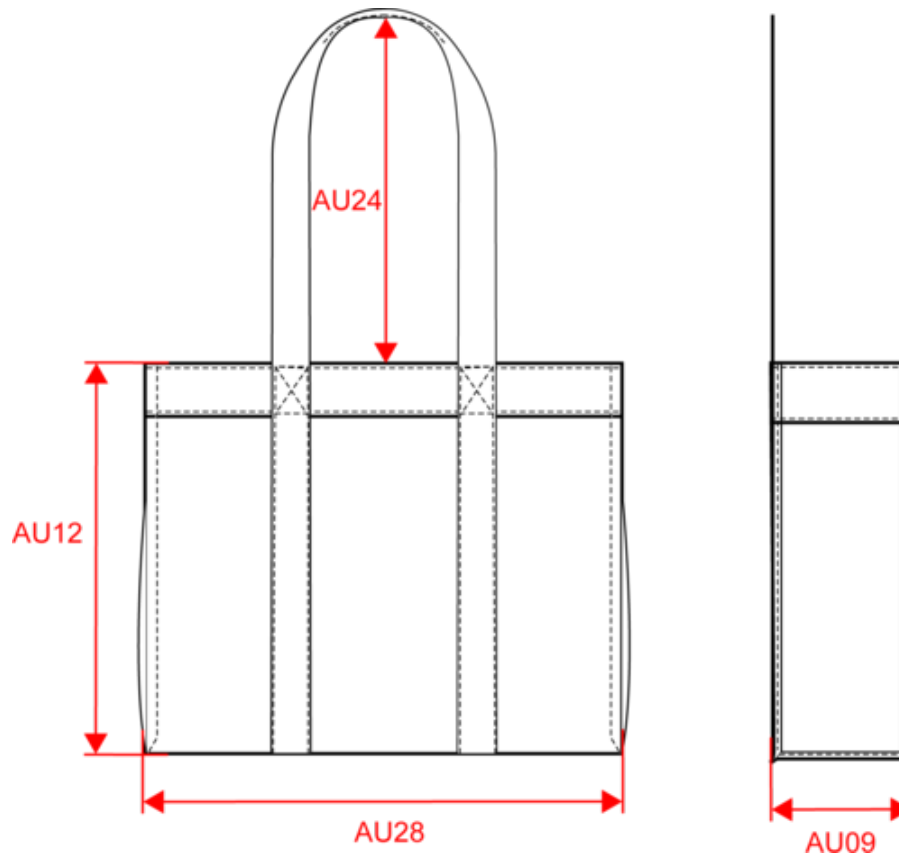





Mesures en cm	One Size
AU09 - Profondeur du bas	22.00
AU12 - Hauteur totale	38.00
AU24 - Hauteur poignée	30.00
AU28 - Largeur bas	44.00



KINS114

## Grand sac shopping recyclé à soufflet

### Informations Couleurs

	<b>Black Night</b> RVB : 39,39,41 Pantone C : Neutral Black C Pantone TCX : 19-4006TCX		<b>Nippon Ecu</b> RVB : Pantone C : Pantone TCX :		<b>Ecume</b> RVB : 221,211,194 Pantone C : 482C Pantone TCX : 12-0304TCX		<b>Nippon Black</b> RVB : Pantone C : Pantone TCX :
---	---	---	--	---	---	---	--

Logistique  1  30

Sizes	Width (cm)	Height (cm)	Length (cm)	Net weight (kg)	Gross weight (kg)	Pieces/Box	Pieces/Bundle
One Size	47.00000	30.00000	42.00000	11.00000	12.00000	30	1