

KINS114

Large recycled gusseted shopping

- Zipped inside pocket.
- In 100% eco-friendly recycled materials.

Recycled cotton / recycled polyester. 75% recycled cotton / 22% recycled polyester / 3% other fibers (Ecume), 67% recycled cotton / 30% recycled polyester / 3% other fibers (Black Night). The contrasting coloured handles feature Japanese-inspired graphics and are sewn all the way down the whole bag for a touch of originality and to make it much more durable. Inside pocket with zip fastening to safely store your keys and phone. Magnetic button clasp.

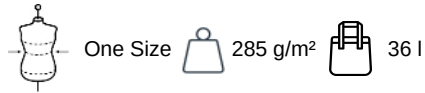

Certifications



More information

Logistic



Country of origin

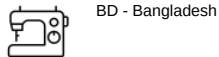

Customs code



KINS114

Large recycled gusseted shopping

Dimensions (cm)

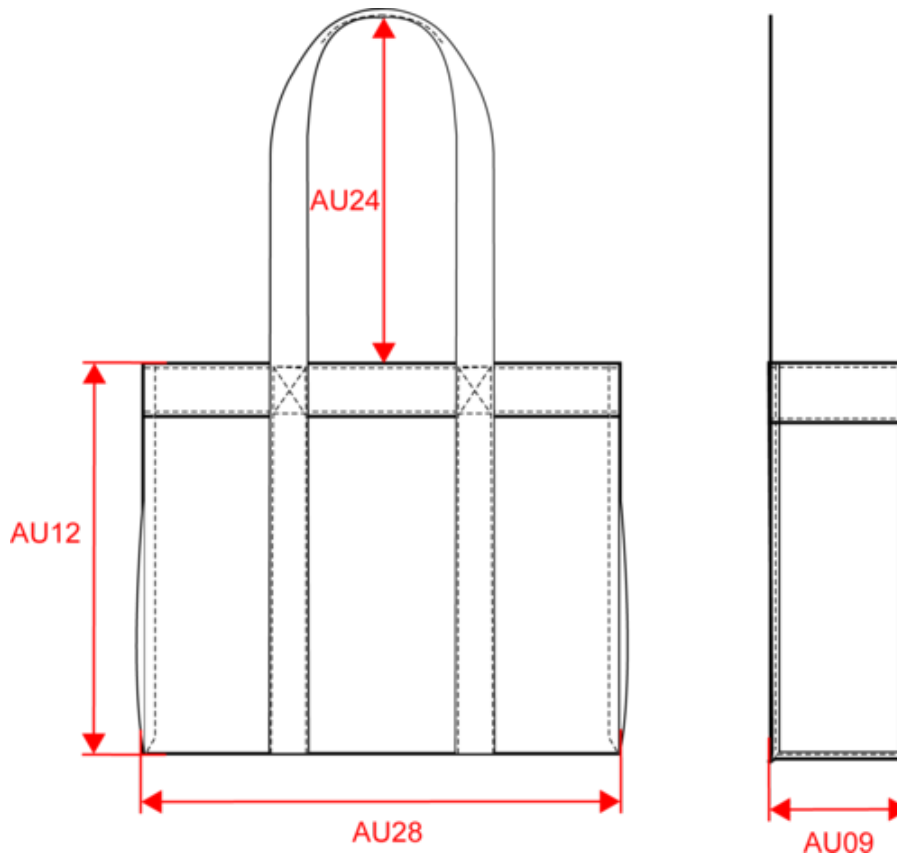



Measurements in cm	One Size
AU09 - Depth of bottom part	22.00
AU12 - Total height	38.00
AU24 - Handle height	30.00
AU28 - Bottom width	44.00



KINS114

Large recycled gusseted shopping

Colours information

 Black Night RVB : 39,39,41 Pantone C : Neutral Black C Pantone TCX : 19-4006TCX	 Nippon Ecu RVB : Pantone C : Pantone TCX :	 Ecume RVB : 221,211,194 Pantone C : 482C Pantone TCX : 12-0304TCX	Nippon Black RVB : Pantone C : Pantone TCX :
---	--	---	--

Logistic  1  30

Sizes	Width (cm)	Height (cm)	Length (cm)	Net weight (kg)	Gross weight (kg)	Pieces/Box	Pieces/Bundle
One Size	47.00000	30.00000	42.00000	11.00000	12.00000	30	1