

KARIBAN

K616

Coupe-vent unisexe

- Matière souple et ultra légère.
- Pratique et repliable grâce au système K-WAY®.
- Protection contre vents et averses.

100% polyester. Capuche dans le col avec patte auto-agrippante. 2 poches zippées devant. Cordon de serrage au bas. Bas de manches élastiqués. Repliable dans sa poche sur la base du système K-WAY®. Fermeture zippée ton sur ton.



Tableau équivalence des tailles par pays en dernière page.

Certifications

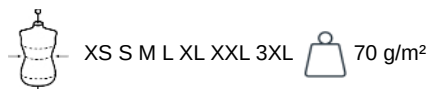

Informations Complémentaires

Logistique



Pays d'origine

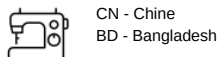

Code douanier

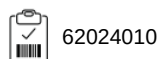

Existe aussi en version



K6102

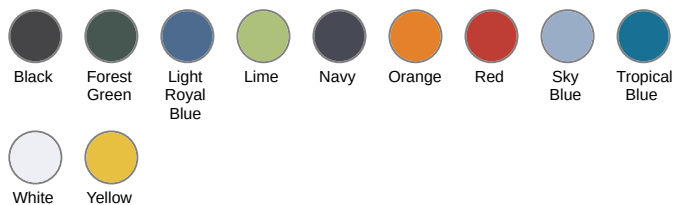

KARIBAN

K616

Coupe-vent unisexe

Dimensions (cm)

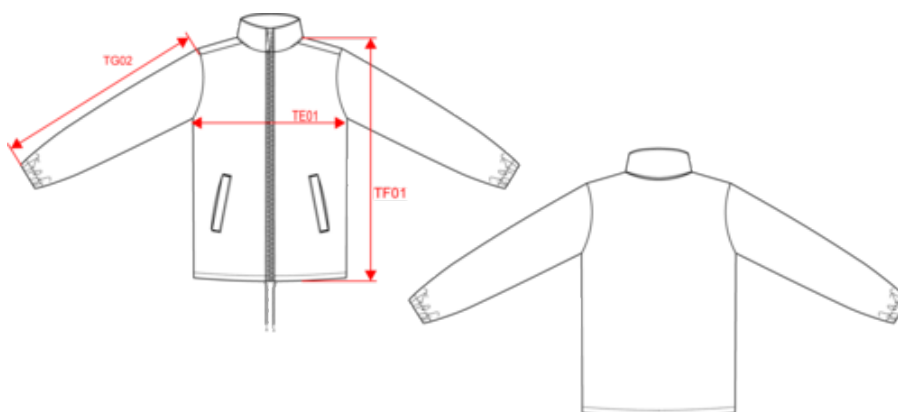











Mesures en cm	XS	S	M	L	XL	XXL	3XL
TE01 - 1/2 largeur poitrine à 1.5cm de l'emmanchure	55.00	58.00	61.00	64.00	67.00	70.00	73.00
TF01 - Hauteur totale de l'HSP	75.50	77.50	79.50	81.50	83.50	85.50	87.50
TG02 - Longueur manche longue	60.00	61.50	63.00	64.50	66.00	67.50	69.00



KARIBAN

K616

Coupe-vent unisexe

Informations Couleurs

 Black RVB : 35,35,37 Pantone C : Black Pantone TCX : 19-4004TCX	 Forest Green RVB : 41,62,48 Pantone C : 5605C Pantone TCX : 19-5918TCX	 Light Royal Blue RVB : 53,95,151 Pantone C : 653C Pantone TCX : 18-4041TCX	 Lime RVB : 151,202,91 Pantone C : 367C Pantone TCX : 14-0244TCX	 Navy RVB : 41,46,56 Pantone C : 433C Pantone TCX : 19-4012TCX
 Orange RVB : 252,107,16 Pantone C : 1585C Pantone TCX : 16-1364TCX	 Red RVB : 195,32,54 Pantone C : 200C Pantone TCX : 19-1664TCX	 Sky Blue RVB : 136,169,206 Pantone C : 5425C Pantone TCX : 14-4121TCX	 Tropical Blue RVB : 0,111,159 Pantone C : 7468C / White Pantone TCX : 18-4537TCX / 11-0601TCX	 White RVB : 236,236,252 Pantone C : White Pantone TCX : 11-0601TCX
 Yellow RVB : 254,186,36 Pantone C : 1235C Pantone TCX : 15-0955TCX				

Logistique  10  50

Sizes	Width (cm)	Height (cm)	Length (cm)	Net weight (kg)	Gross weight (kg)	Pieces/Box	Pieces/Bundle
XS	40.00	29.00	60.00	10.6	12.8	50	10
S	40.00	29.00	60.00	11.3	13.5	50	10
M	40.00	29.00	60.00	12	14.2	50	10
L	40.00	31.00	60.00	12.8	15	50	10
XL	40.00	31.00	60.00	13.5	15.6	50	10
XXL	40.00	31.00	60.00	14.1	16.2	50	10
3XL	40.00	31.00	60.00	14.7	16.8	50	10