

KARIBAN

K6118

Bodywarmer doublé polaire unisexe

- Matière résistante, souple et facile d'entretien.
- Pièce polyvalente et fonctionnelle grâce à ses nombreuses poches.
- Bodywarmer essentiel du vestiaire workwear, chaud et confortable doublé en polaire.

Extérieur : 100% polyester microfibre. Garniture intérieure 100% polyester. Doublure intérieure polaire 100% polyester. Chaud et confortable. 2 poches extérieures zippées passepoilées, 1 poche intérieure avec bande auto-agrippante. Zips, finitions et doublures ton sur ton. 1 zip côté cœur et 1 zip au bas du vêtement pour accès personnalisation.



XS S M L XL XXL 3XL 4XL  525 g/m²

Tableau équivalence des tailles par pays en dernière page.

Certifications



Informations Complémentaires

Logistique



Pays d'origine



CN - Chine

Code douanier



62024010



KARIBAN

K6118

Bodywarmer doublé polaire unisexe

Dimensions (cm)

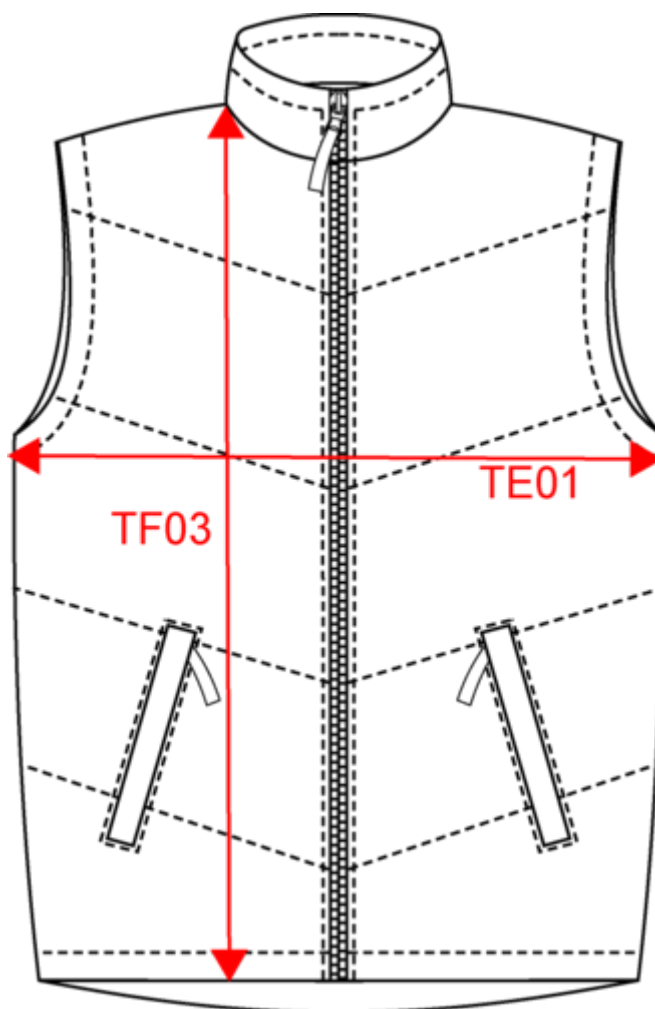











Mesures en cm	XS	S	M	L	XL	XXL	3XL	4XL
TE01 - 1/2 largeur poitrine à 1.5cm de l'emmanchure	53.00	56.00	59.00	62.00	65.00	68.00	71.00	74.00
TF03 - Hauteur totale devant de l'HSP	68.50	70.50	72.50	74.50	76.50	78.50	80.50	82.50

KARIBAN

K6118

Bodywarmer doublé polaire unisexe

Informations Couleurs

 Black RVB : 35,35,37 Pantone C : Black Pantone TCX : 19-4004TCX	 Convoy Grey RVB : 91,92,99 Pantone C : 7540C Pantone TCX : 18-0201TCX	 Dark green RVB : 0,82,67 Pantone C : 7729C Pantone TCX : 19-5420TCX	 Dark Grey RVB : 63,60,60 Pantone C : 447C Pantone TCX : 19-0000TCX	 Light Royal Blue RVB : 53,95,151 Pantone C : 653C Pantone TCX : 18-4041TCX
 Mossy Green RVB : 74,69,57 Pantone C : 7771C Pantone TCX : 19-0414	 Navy RVB : 41,46,56 Pantone C : 433C Pantone TCX : 19-4012TCX	 Orange RVB : 242,102,34 Pantone C : Orange021C Pantone TCX : 16-1363TCX	 Red RVB : 195,32,54 Pantone C : 200C Pantone TCX : 19-1664TCX	 White RVB : 236,236,252 Pantone C : White Pantone TCX : 11-0601TCX

Logistique  1  10

Sizes	Width (cm)	Height (cm)	Length (cm)	Net weight (kg)	Gross weight (kg)	Pieces/Box	Pieces/Bundle
XS	40.00000	30.00000	60.00000	5.20000	6.20000	10	1
S	40.00000	30.00000	60.00000	5.50000	6.50000	10	1
M	40.00000	30.00000	60.00000	6.00000	7.00000	10	1
L	40.00000	30.00000	60.00000	6.20000	7.20000	10	1
XL	40.00000	30.00000	60.00000	6.60000	7.60000	10	1
XXL	40.00000	35.00000	60.00000	7.20000	8.20000	10	1
3XL	40.00000	35.00000	60.00000	7.70000	8.70000	10	1
4XL	40.00000	35.00000	60.00000	8.00000	9.00000	10	1